



Ultrasonic Pro™ Level Sensor Installation and Operation Manual UPRO-3003

Ultrasonic Pro™ Distance/Level Sensor

See Water's Ultrasonic Pro™ Level Sensor combines an ultrasonic sensor, temperature sensor, ultrasonic servo circuit, and transmission circuit; It also uses SMD components and ASIC. The shell is made of quality NLEPF synthetic material with solid texture and good acoustic characteristics. The body is waterproof and can be used in a wide variety of applications. The Ultrasonic Pro™ Level Sensor is also easy to install and simple to maintain.

Model	Range: ft (m)	Cable Length: ft (m)
UPRO-3003	15ft (5m)	50ft (15m)

Features:

- Supports M49*1.5mm threaded into type installation and coil clamping type installation
- Many output options: Customizable with a 4-20mA three-wire system, 1-5v, RS485 and more
- Less than 9°C design, resolution 3mm, less than 200ms response time
- Sealed so that it can be safely used for liquid level measurement in a wide variety of applications, including with high-temperature toxic, volatile, flammable, and strongly corrosive liquids
- Housing consists of NLEPF synthetic material, IP66 waterproof, anti-skid, anti-corrosion, anti-explosion structure
- Anti-jamming high quality terminal blocks for long-term stability and reliability
- Two-year limited warranty

Dimensions:

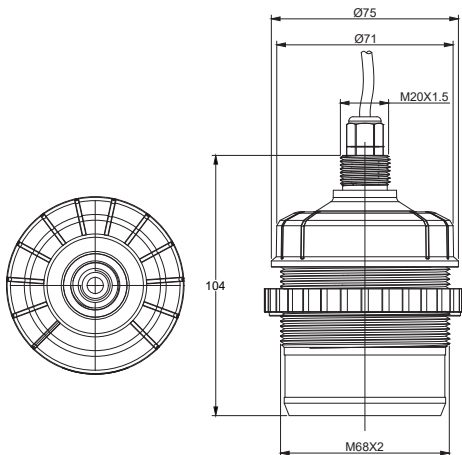

WARNING: A voltage potential between the ground wire of the unit and the ground of other equipment can lead to electrolytic corrosion. Always ensure the grounding system provides an equipotential between the transmitter and the earthing ground connection. Avoid using the power system protective ground since this will often have a significant potential difference to the transmitter ground. Also, note that dissimilar metals in the ground system may cause electrolysis corrosion of the transmitter or other components in the ground system.

During installation, connect a voltmeter or ammeter between the shield ground wire and the grounding connection. If there is a measurable voltage or current electrolytic corrosion may be a serious possibility. If there is a potential difference then some isolation system will be required. Improper grounding may lead to damage or poor function.

Electrical Properties:

- **Power Requirement:** DC24V/300mA
- **Output Signal:**
 - Analog Signal: 4~20mA; 1~5V; Load>300Ω; 1~10V
 - Digital Signal: RS485/RS232
- **Scanning Frequency:** 20.0KHz ~ 43.0KHz
- **Electrical Connection:** Wire pigtail
- **Consumption:** <1.5W
- **Accuracy:** 0.5%FS (at blind-fold drive away, 25°C)

Mechanical Properties:

- **Material:** ABS/Nylon
- **Explosion Proof:** ExiAll BT4Gb
- **Protection Class:** IP65 (default); IP67, IP68 (customized)

Operating Condition:

- **Operating Temperature:** -20°C ~ 60°C (-4°F ~ 140°F)



www.seewaterinc.com
951.487.8073 • 888.733.9283 • info@seewaterinc.com
22220 Opportunity Way, Suite 101 • Riverside, CA 92518

Installation:

Ultrasonic Sensor:

The measure reference surface is the bottom line of the sensor. The highest solid level cannot enter the blind area. The level measurement should avoid the feeling hole; aim toward the smoother level surface. It is better to use a sun/rain shade when mounting in an application that is exposed to weather elements. When mounting, sensor should be kept a distance from the wall surface because of the beam angle of the ultrasonic wave. When measuring the object level, the feeding hole should be avoided to prevent interference with the ultrasound echo.

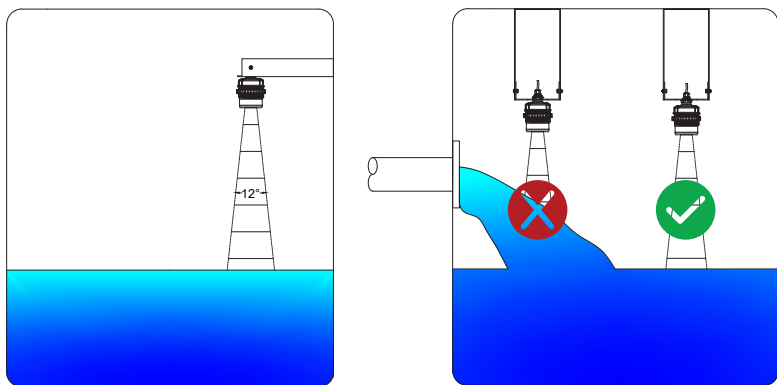
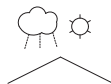

Inflowing medium: Do not mount the sensor in or above the filling stream. Make sure to detect the medium surface, not the inflowing liquid.

It is possible to achieve both horizontal and vertical mounting orientations by rotating the sensor holder to the appropriate angle. The sensor holder can also be adjusted to compensate for out of plumb conditions allowing the sensor to be perpendicular to the medium.

Wiring Connection:

1. Wiring diagram of current (voltage) output connect with secondary unit.

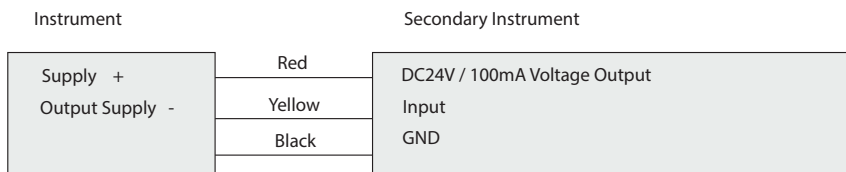

2. Wiring diagram of serial output connecting with PC

External power / instrument / 485-232 / PC

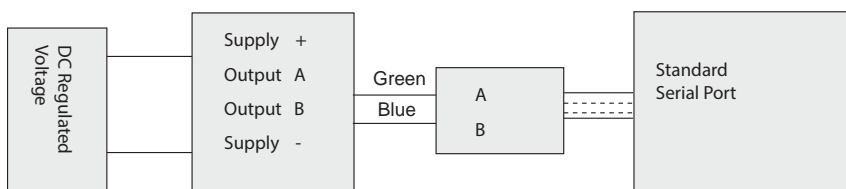

Mounting Bracket:

Using the bracket as a template, place a level across the top and hold it in the desired location. Mark the four 3/16" holes. Use a drill bit suitable for the intended substrate and screw diameter and drill out the four holes (A 10-32 x 1 1/2" stainless steel screw is recommended). The mounting holes can be bored to 1/4" to accept a larger screw (A minimum of 1" penetration into the substrate is recommended). The tolerances of the drill bit used should meet the requirements of ANSI Standard B212.15. Position the bracket, insert the screw through the mounting hole of the bracket and tighten the screw until it is fully embedded.

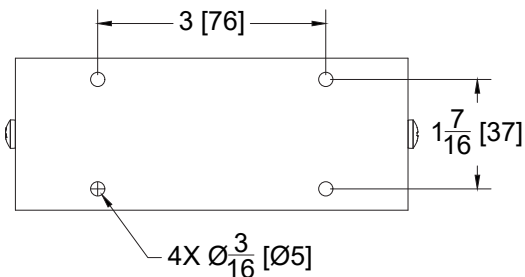

Slide the cord of the sensor through the slot in the mounting bracket and use the included nut to secure the sensor to the mount.

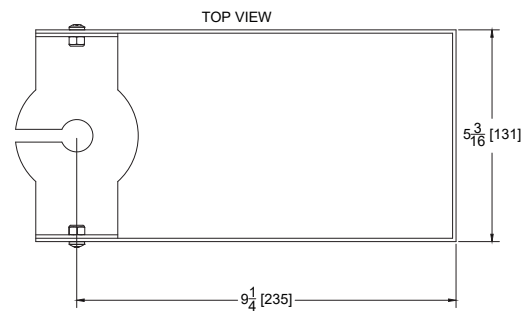

Warranty:

See Water, Inc. warrants that products of its manufacture are free from defects in material and workmanship for a period of 2 years from the date of purchase. This date shall be determined by the date on the invoice and the serial number on the product.

Replacement of the product is at the discretion of See Water, Inc. This warranty is valid when the product is installed in compliance with the manufacturer's installation instructions. The manufacturer's obligation under this warranty shall be limited to the repair or replacement of any parts found by the manufacturer to be defective.

www.seewaterinc.com
951.487.8073 • 888.733.9283 • info@seewaterinc.com
22220 Opportunity Way, Suite 101 • Riverside, CA 92518